

Find the value of each variable.

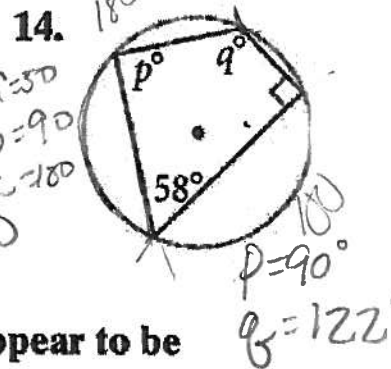

Find the value of each variable. You may assume that rays that appear to be tangent are tangent.

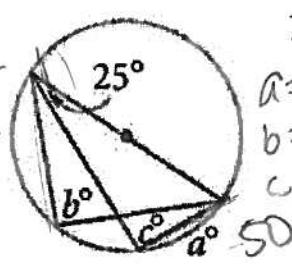
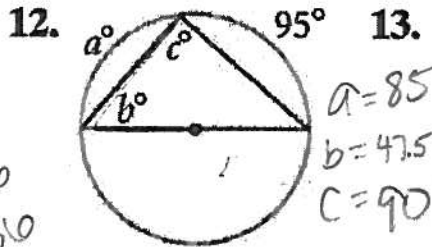
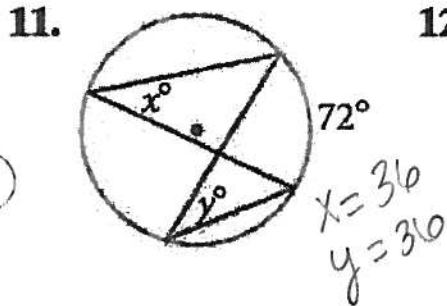
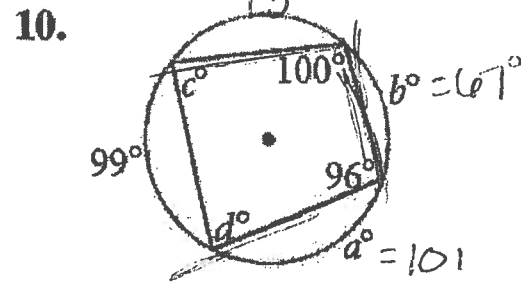
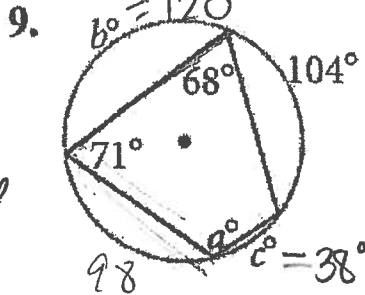
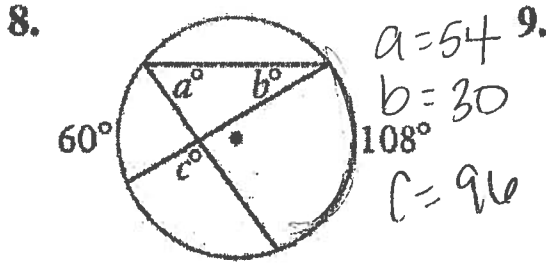
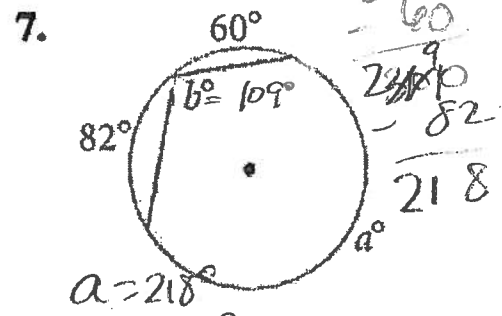
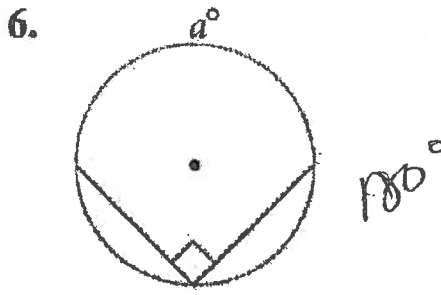
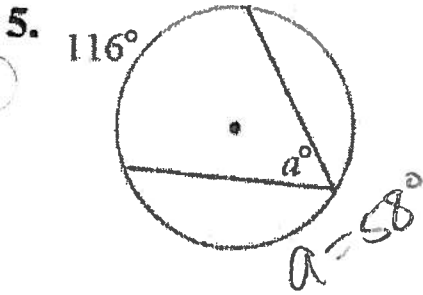